

Top Fan Tray

- Expel heat from the roof of the cabinet
- Tool-less mounting for easy installation
- Provide low noise and high airflow performance
- 2 fans (216 CFM)

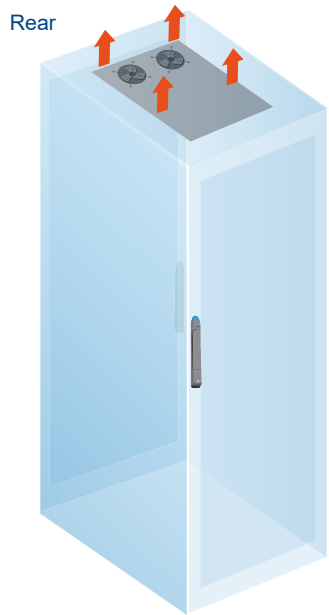

Part no. :
TF-602

Top view :

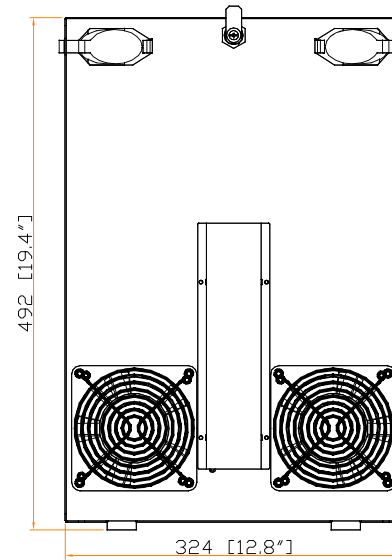

Side view :

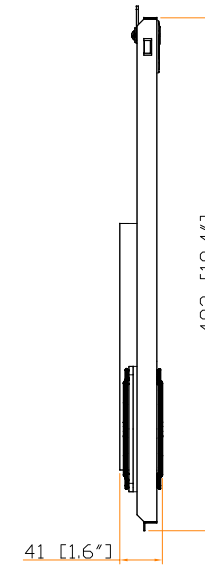

Front view :

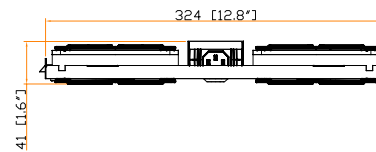

The company reserves the right to modify product specifications without prior notice and assumes no responsibility for any error which may appear in this publication.

Copyright 2020 Austin Hughes Electronics Ltd. All rights reserved.

Description	: - Expel heat from the roof of the cabinet - Easily install into the top of the enclosure - Provide low noise and high airflow performance
	: - 2 fans (216 CFM)
Fan size	: 120 (W) x 120 (H) x 25 (D) mm
Material	: Steel
Coating	: Power
Color	: Black (RAL-9005) or White (RAL-9016)
Dimension	: 324 (W) x 492 (H) x 41 (D) mm / 12.8 (W) x 19.4 (H) x 1.6 (D) in.
Gross weight	: - kg / - lb
Environmental	: RoHS2 & REACH compliant by SGS