

1-Phase Basic PDU specification drawing

230V 16A / 20A / 32A PDU : C13 x 8

unit : mm

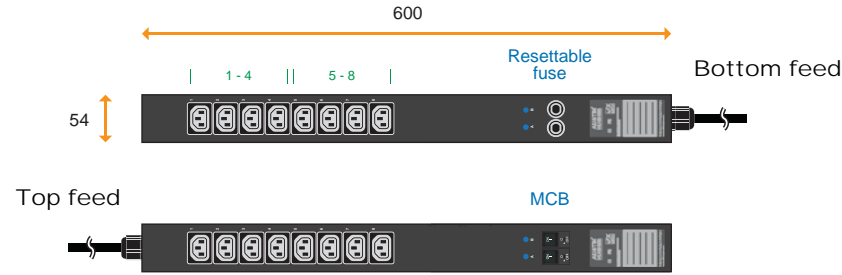

PDU Feed	Code
Bottom	B
Top	T



IEC 60309 Inlet

32A model :	Circuit Protection
V8C13-32A/F_EN/3B-1	Resettable Fuse x 2
V8C13-32A/CR_EN/3T-1	1-pole MCB x 2

Input Rating : 32Amp, 230V
Cordset : 3 meter 4.0mm sq. H05V V-F cordset
Protection : 16A resettable fuse or 16A hydraulic MCB x 2
Circuit A : Output 16A max., C13 #1-4
Circuit B : Output 16A max., C13 #5-8
Weight : Net 3.14 Kg / Gross 4.38 Kg

Chassis Color	Code
Black	1
White	2
Red	3
Blue	4
Green	5
Orange	6
Yellow	7
Purple	8

Standard color: Black



Open end

20A model :	Circuit Protection
V8C13-20A/F_OE/3B-1	Resettable Fuse x 1
V8C13-20A/CR_OE/3T-1	1-pole MCB x 1

Input Rating : 20Amp, 230V
Cordset : 3 meter 2.5mm sq. H05V V-F cordset
Protection : 20A resettable fuse or 20A hydraulic MCB x 1
Circuit : Output 20A max., C13 #1-8
Weight : Net 1.68 Kg / Gross 2.92 Kg



IEC 60309 Inlet

16A model :	Circuit Protection
V8C13-16A/F_EN/3B-1	Resettable Fuse x 1
V8C13-16A/CR_EN/3T-1	1-pole MCB x 1

Input Rating : 16Amp, 230V
Cordset : 3 meter 1.5mm sq. H05V V-F cordset
Protection : 16A resettable fuse or 16A hydraulic MCB x 1
Circuit : Output 16A max., C13 #1-8
Weight : Net 1.61 Kg / Gross 2.85 Kg



IEC320 C20

16A model :	Circuit Protection
V8C13-16A/F_C20/3B-1	Resettable Fuse x 1
V8C13-16A/CR_C20/3T-1	1-pole MCB x 1

Input Rating : 16Amp, 230V
Cordset : 3 meter 1.5mm sq. H05V V-F cordset
Protection : 16A resettable fuse or 16A hydraulic MCB x 1
Circuit : Output 16A max., C13 #1-8
Weight : Net 1.53 Kg / Gross 2.77 Kg

Operating Temperature : -5 to 60 °C
Storage Temperature : -25 to 65 °C
Operating Altitude : 0 to 2,000 m
Storage Altitude : 0 to 15,000 m
Humidity : 8 to 95% RH, non-condensing

EMC Compliance : CE / EMC certified
Safety Compliance : CE / LVD certified
Environment Compliance : RoHS2 & REACH

Lockable IEC Outlet

- Patented design for InfraPower PDU



C13 Outlet

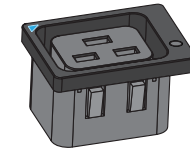

C19 Outlet

Lockable IEC Cable

- Patented design of InfraPower PDU
- Low cost, easy to lock & secure
- Proprietary for lockable IEC outlet
- Applicable to standard IEC outlet
- 6 colors & 3 lengths available
- Custom color & length on request
- VDE & ENEC approval

C13 - C14

H05VV-F 3G 0.75mm²

Cable Color	0.5M	1M	2M
Black	✓	✓	✓
Grey	✓	✓	✓
Red	✓	✓	✓
Blue	✓	✓	✓
Green	✓	✓	✓
Orange	✓	✓	✓



C19 - C20

H05VV-F 3G 1.5mm²

Cable Color	1M	2M
Black	✓	✓
Grey	✓	✓
Red	✓	✓
Blue	✓	✓
Green	✓	✓
Orange	✓	✓

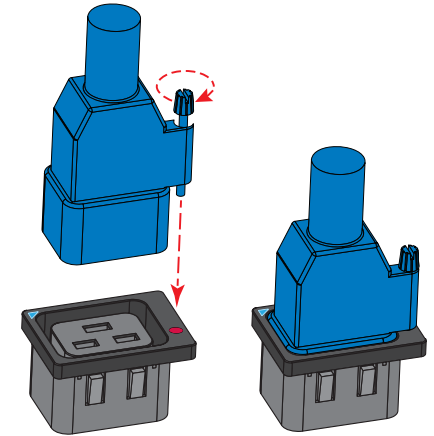

C13 - C14



lockable cable

C19 - C20

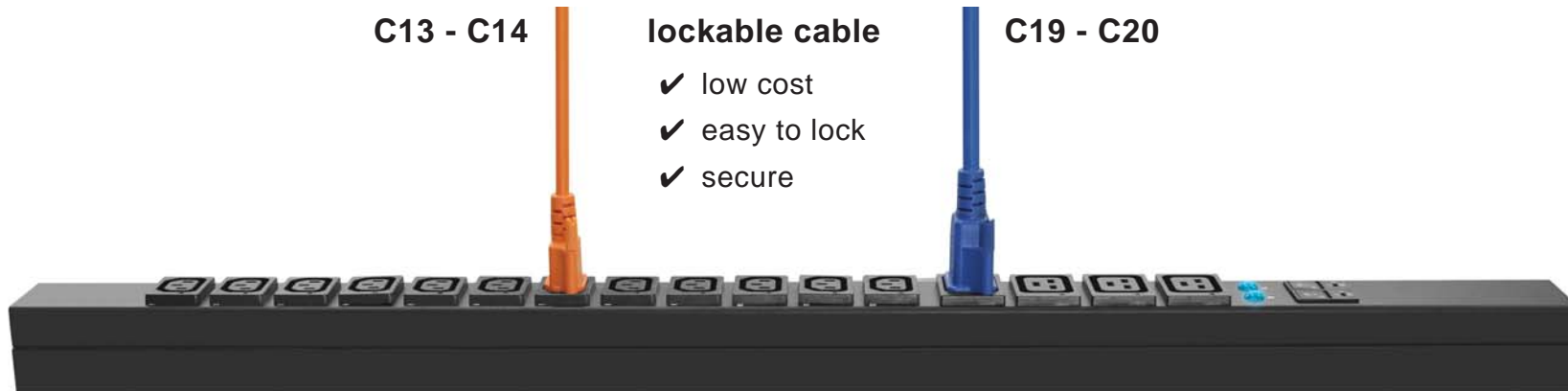
- ✓ low cost
- ✓ easy to lock
- ✓ secure



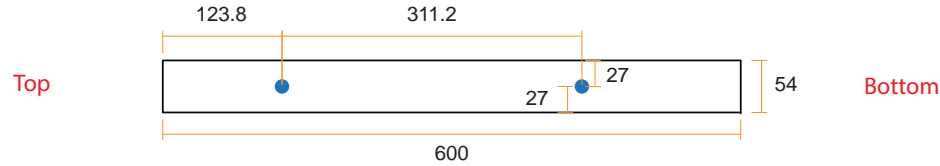
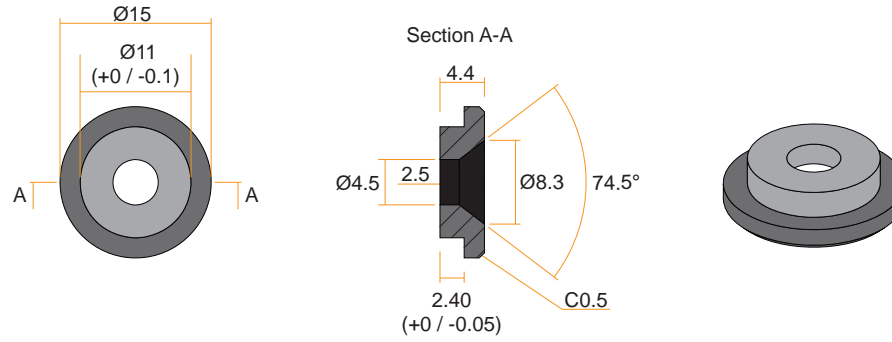

VMS Mounting Button

 x 2 +  x 2
M4 Screw
 - Flat head
 - M4x10mm
PEG



VMB Mounting Bracket

 x 4 +  x 2
M3.2 Screw
 - Flat head
 - M3.2x6mm
Bracket

